

BAC DE RÉTENTION 2 FÛTS - 240 L

Réf. **B2FP24006F**

Informations produit :

Bac de rétention 100% PEHD avec caillebotis
Caillebotis amovible en PEHD
Passage de fourches sur 4 cotés
Encombrement optimisé pour mettre
3 bacs sous une lisse de 2700 mm

Caractéristiques techniques :

Dim. hors tout (L x p x h) : 1212 x 812 x 450 mm
Dim. Caillebotis (L x l) : 1200 x 800 mm
Coloris : Jaune (TEIN006 - Proche RAL 1028)
Capacité de rétention : 240 litres
Capacité de charge (UR) : 650 kg
Nombre de pièces par pile : 5



PLANS

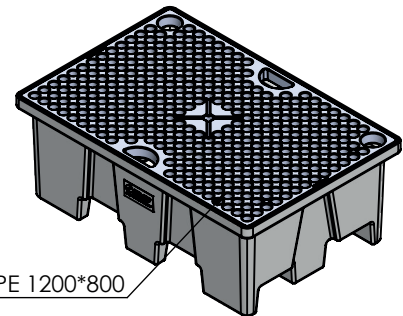
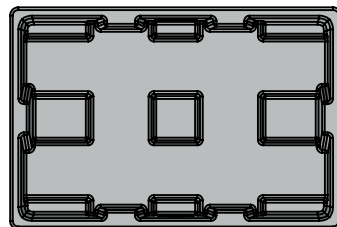
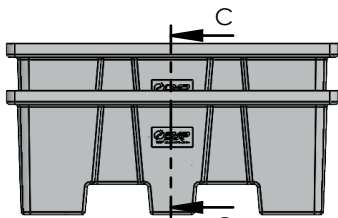

Caillebotis PE 1200*800

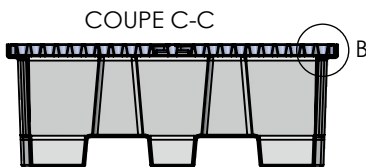
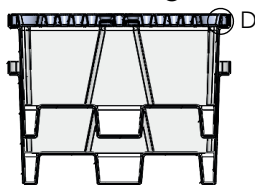

COUPE C-C

COUPE A-A

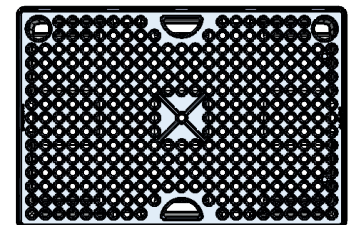
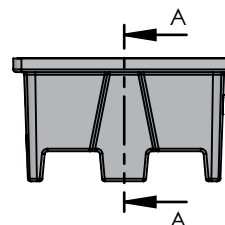
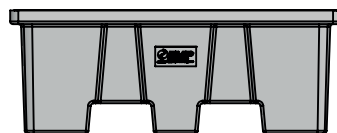

Variations des dimensions et volumes indiqués possibles : +/- 4%. Les teintes RAL indiquées sont les correspondances les plus proches des coloris réels.